

CM 90S4 serie performance

Gru idraulica a montaggio rapido

Hydraulic crane with quick assembling
Grue hydraulique à montage rapide
Hydraulischer Schnellmontagekran
Grúa hidráulica de montaje rápido

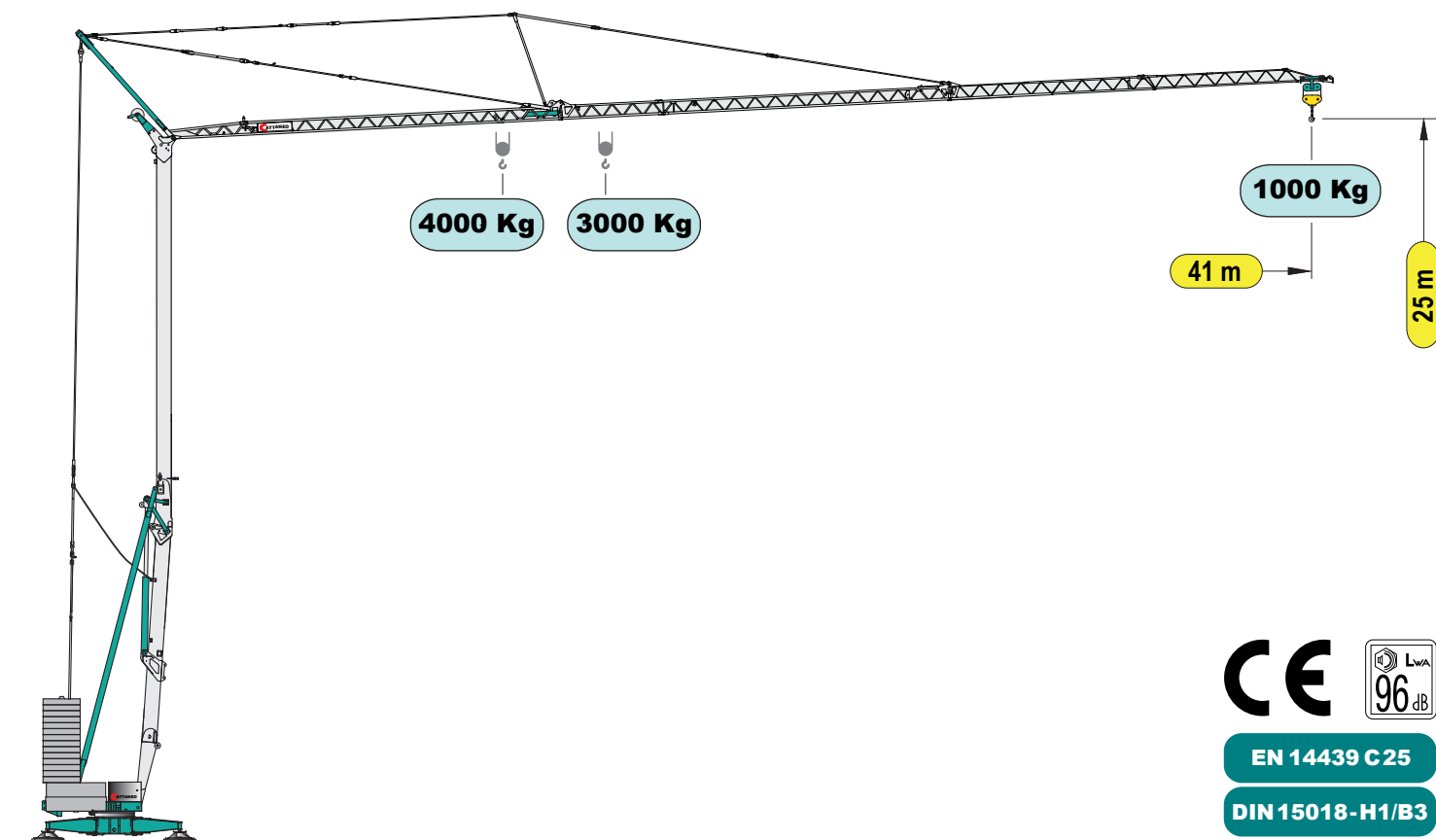

PROGETTO: Ufficio Tecnico LUIGI CATTANEO SpA
COSTRUZIONE: Stabilimenti LUIGI CATTANEO SpA

CATTANEO

Luigi Cattaneo S.p.A.
via Trieste 14 - 20020 Magnago (MI) Italia
tel. +39 331 657132 - fax +39 331 305460
www.cattaneo.gru.it

CM 90S4

 Nessun componente elettrico sul braccio e sulle parti alte della gru

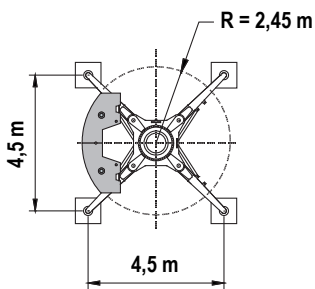
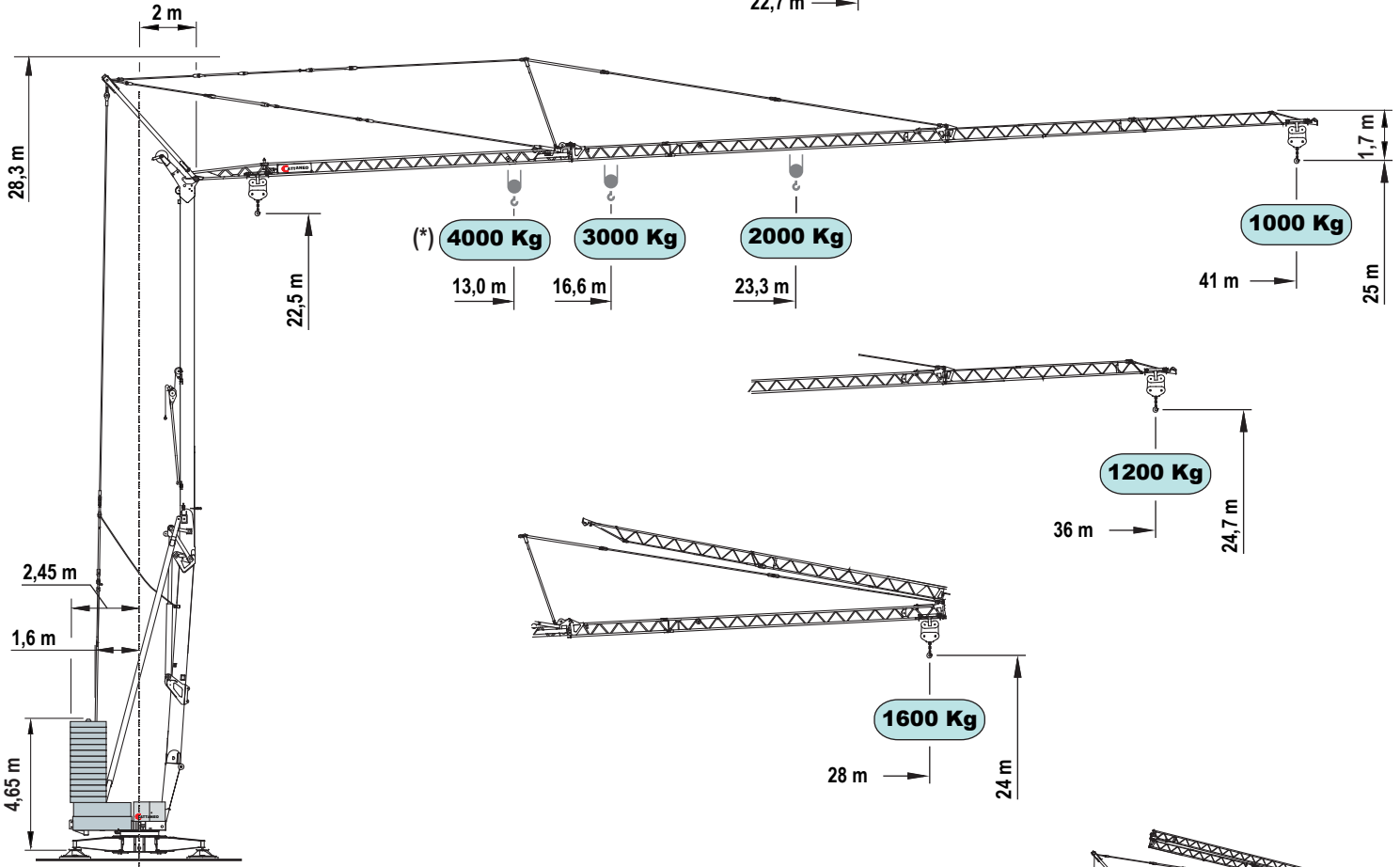
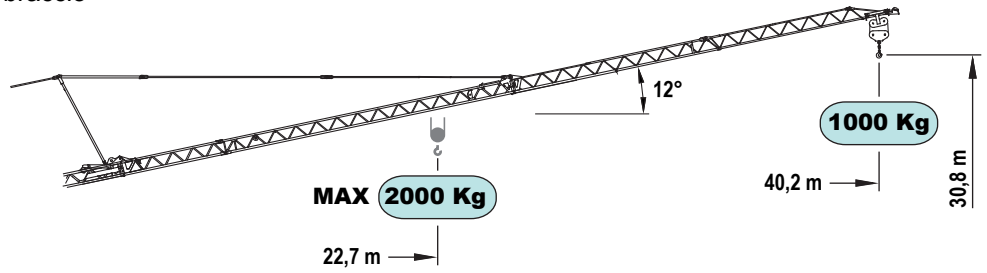

portata massima kg 3000 e 4000
in tiro semplice

(*) Optional

Sistema di autozavorramento

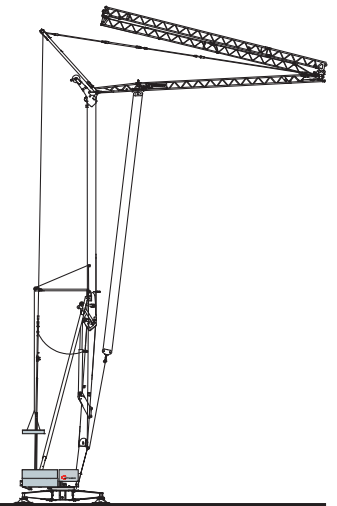

															
Curve di carico	kg	4000	3000	2500	2000	1900	1800	1700	1600	1500	1400	1300	1200	1100	1000
Load diagrams	m	13.0	16.6	19.3	23.3	24.2	25.3	26.5	27.9	29.4	31.1	33.1	35.5	37.8	41.0
Courbes de charge	m	13.1	16.9	19.6	23.6	24.6	25.8	27.0	28.4	30.0	31.7	33.7	36.0		
Lastkurven	m	13.0	16.6	19.4	23.3	24.3	25.4	27.6	28.0						
Curvas de cargas	m				22.7	23.7	24.8	26.0	27.4	28.8	30.5	32.4	34.6	37.0	40.2

Prestazioni - Performances - Prestations - Leistungen - Prestaciones - (*) Optional

kW		400V - 50Hz				16 kW
						(*) 21 kW
inverter	kW/g/min		1°	2°	3°	4°
		m/min	4	20	35	50
(*)		kg	3000	3000	1500	1000
		kg	4000	4000	2000	1500
inverter	3/1400	m/min				10 - 25 - 50
inverter	3,7/900	g/min				0,2 - 0,5 - 0,9

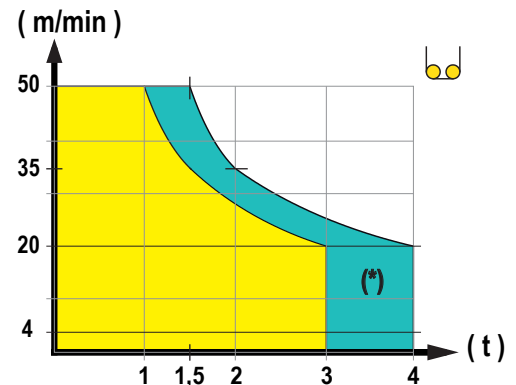

Contrappeso in lastre di cemento armato - Ferro-concrete ballast slabs Contrepoids en plaques de béton armé - Gegenballast aus Stahlbetonplatten - Lastre en hormigón armado

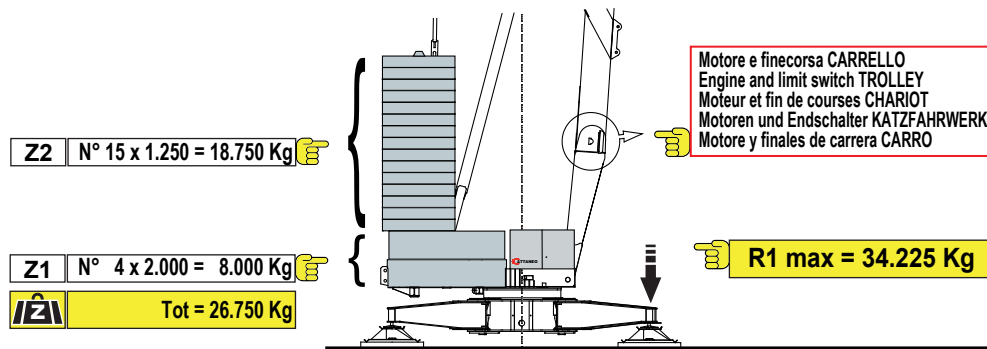

Trasporto - Transport - Transport - Transport - Transporte

